

FIG. 1

Background Art

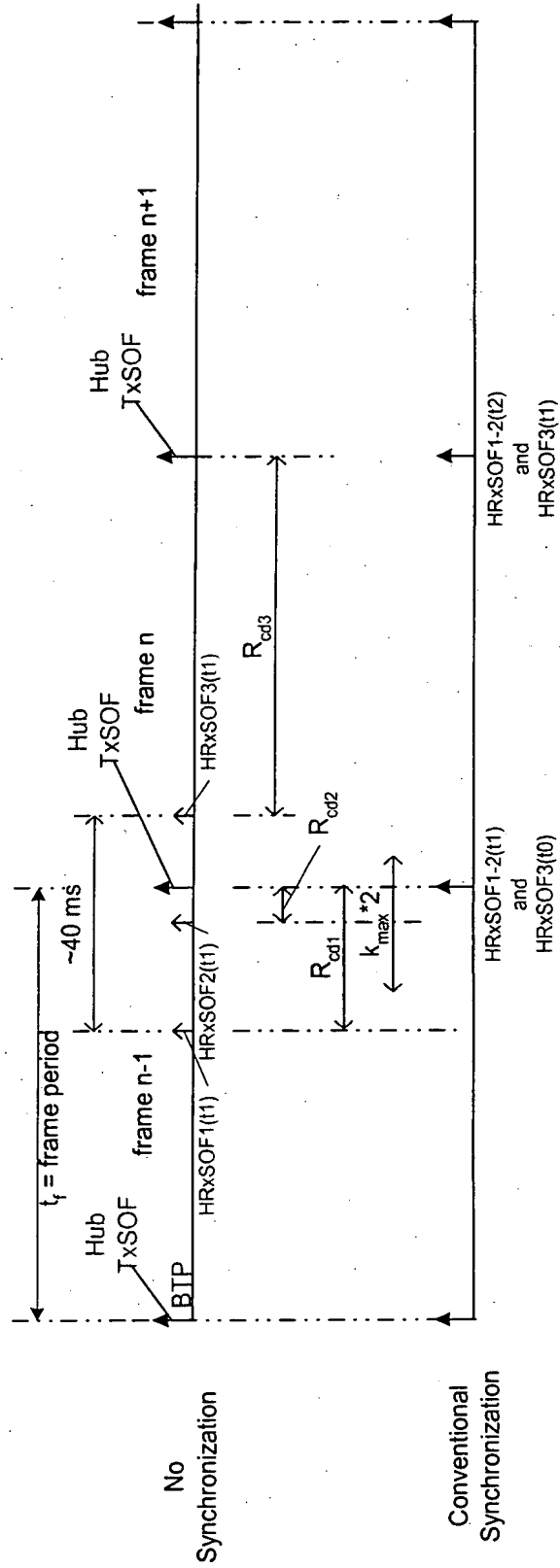

FIG. 2

Background Art

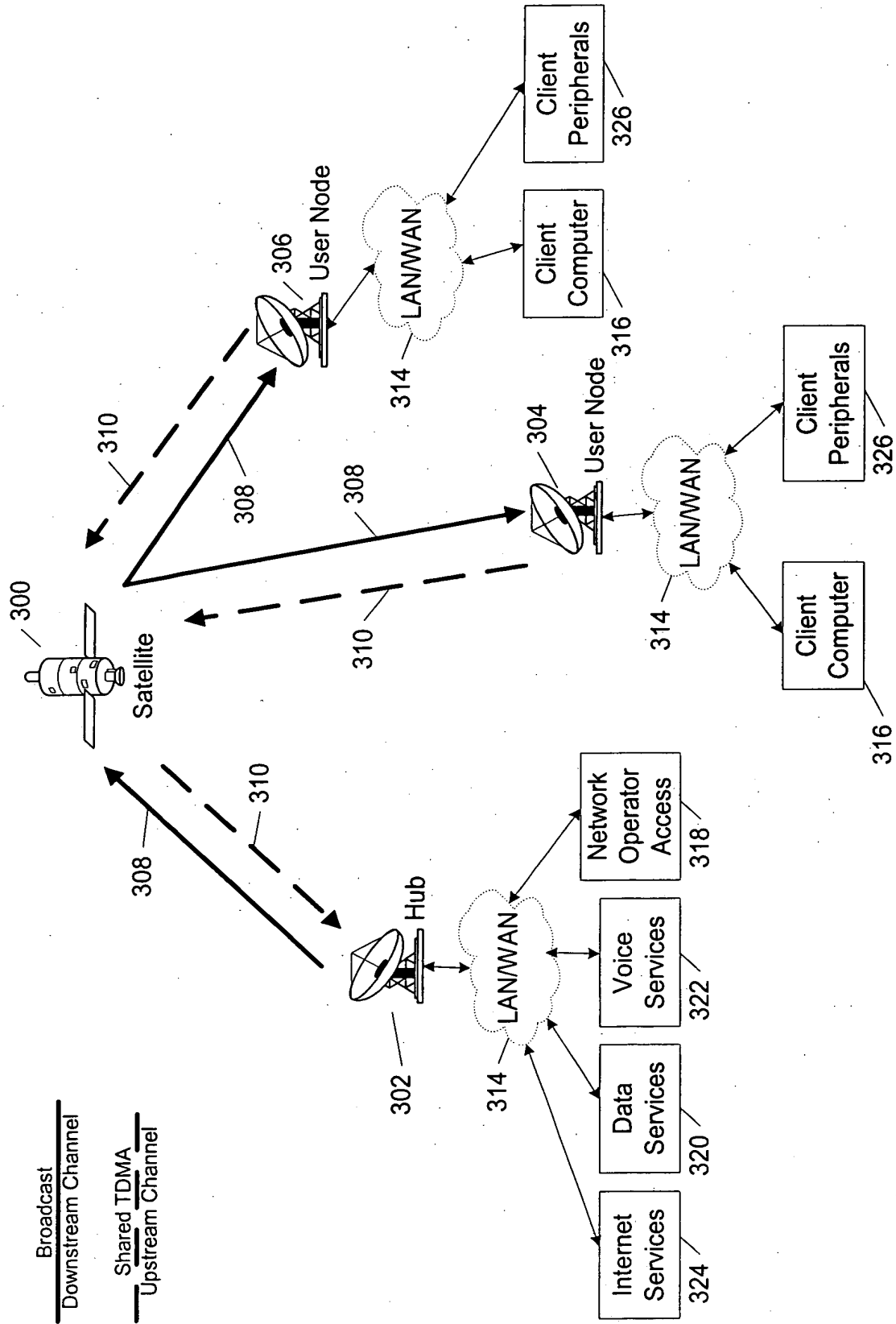

FIG. 3

302

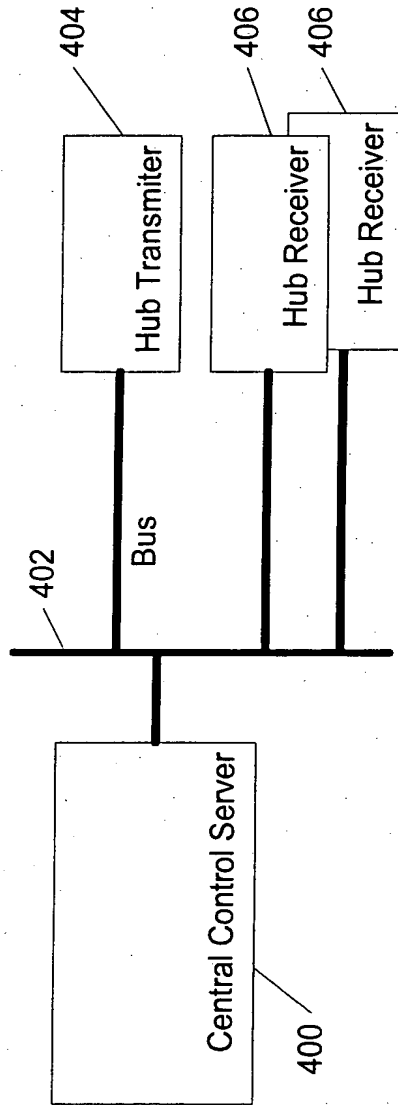

FIG. 4



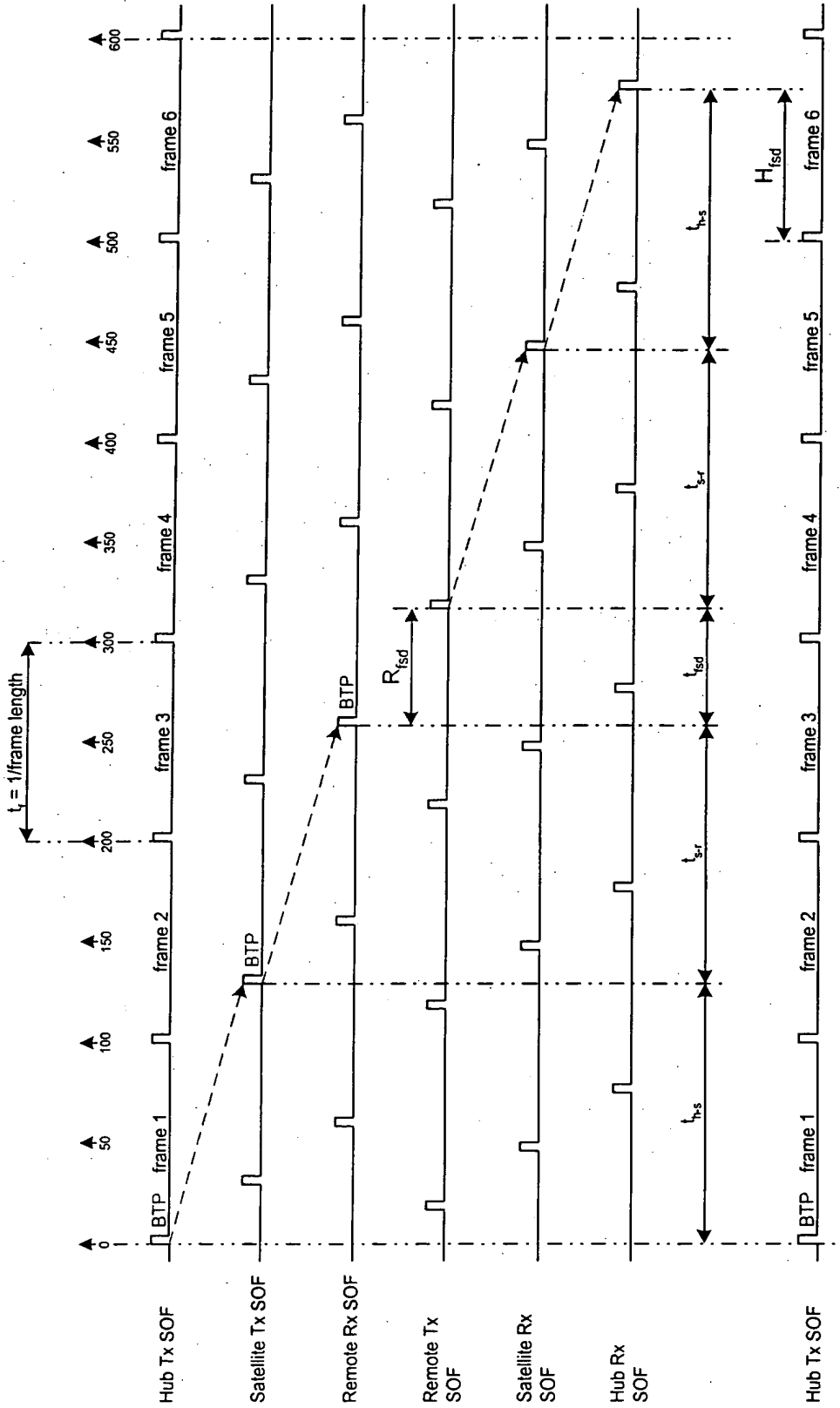

FIG. 6

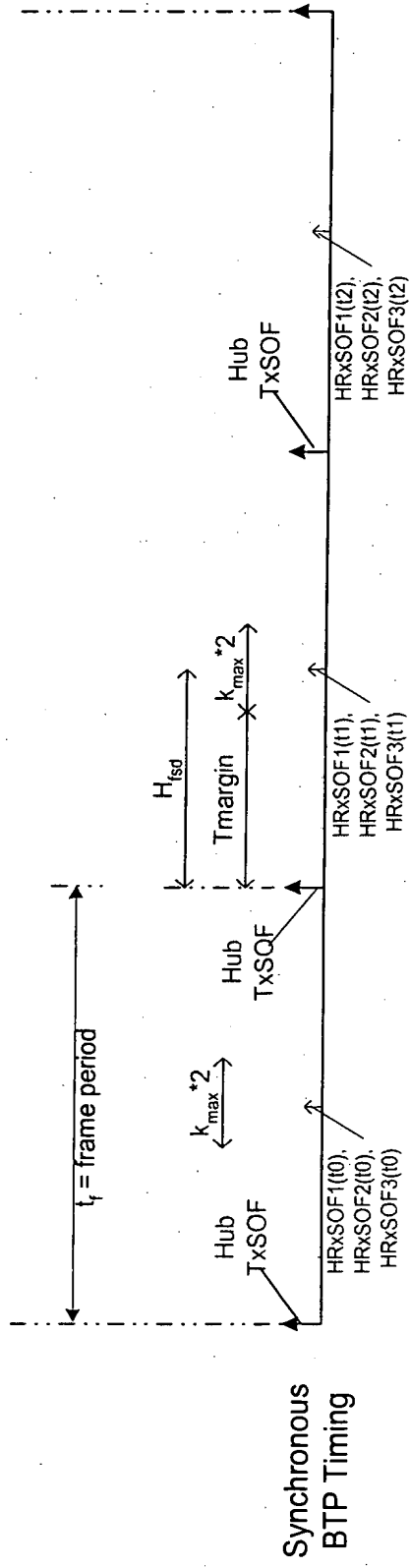

FIG. 7

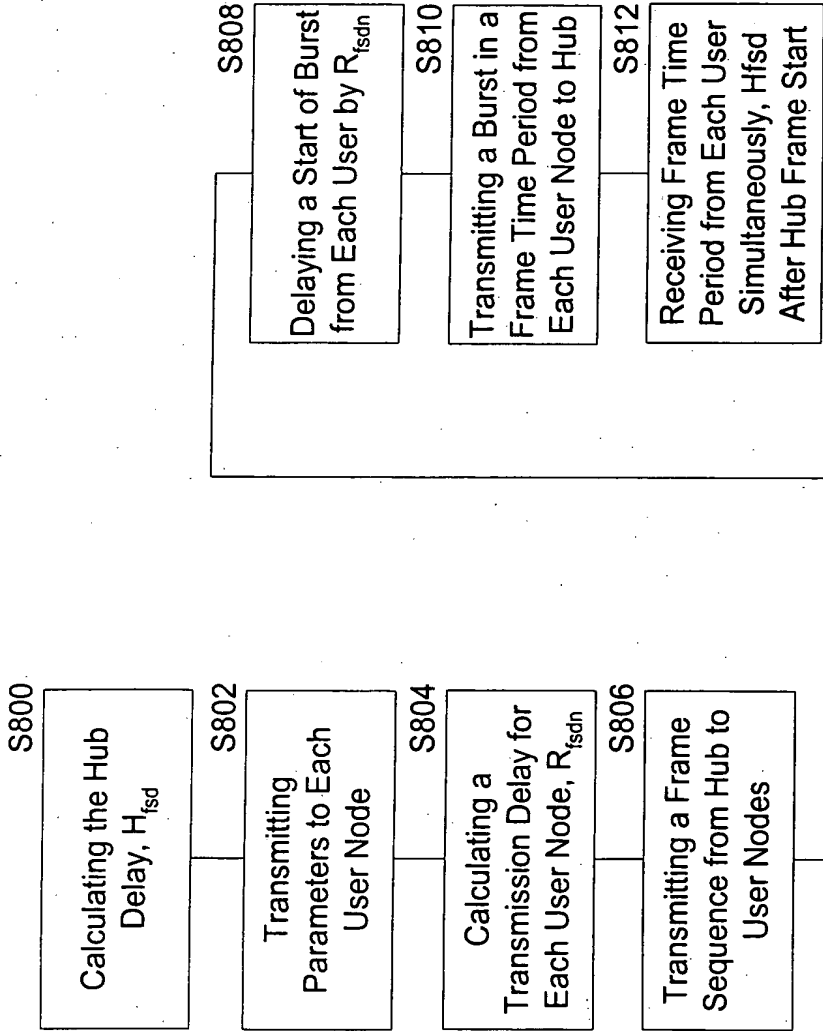

FIG. 8



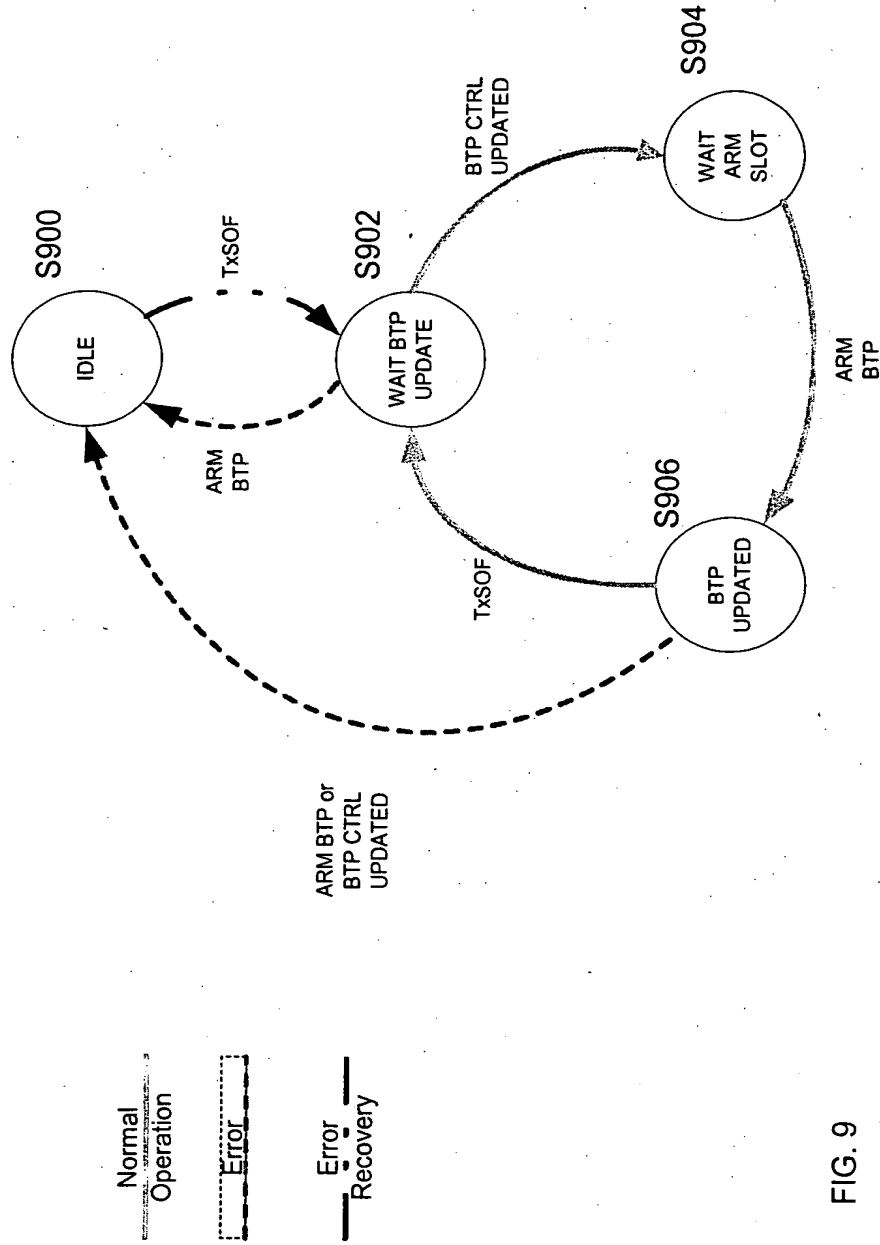

FIG. 9

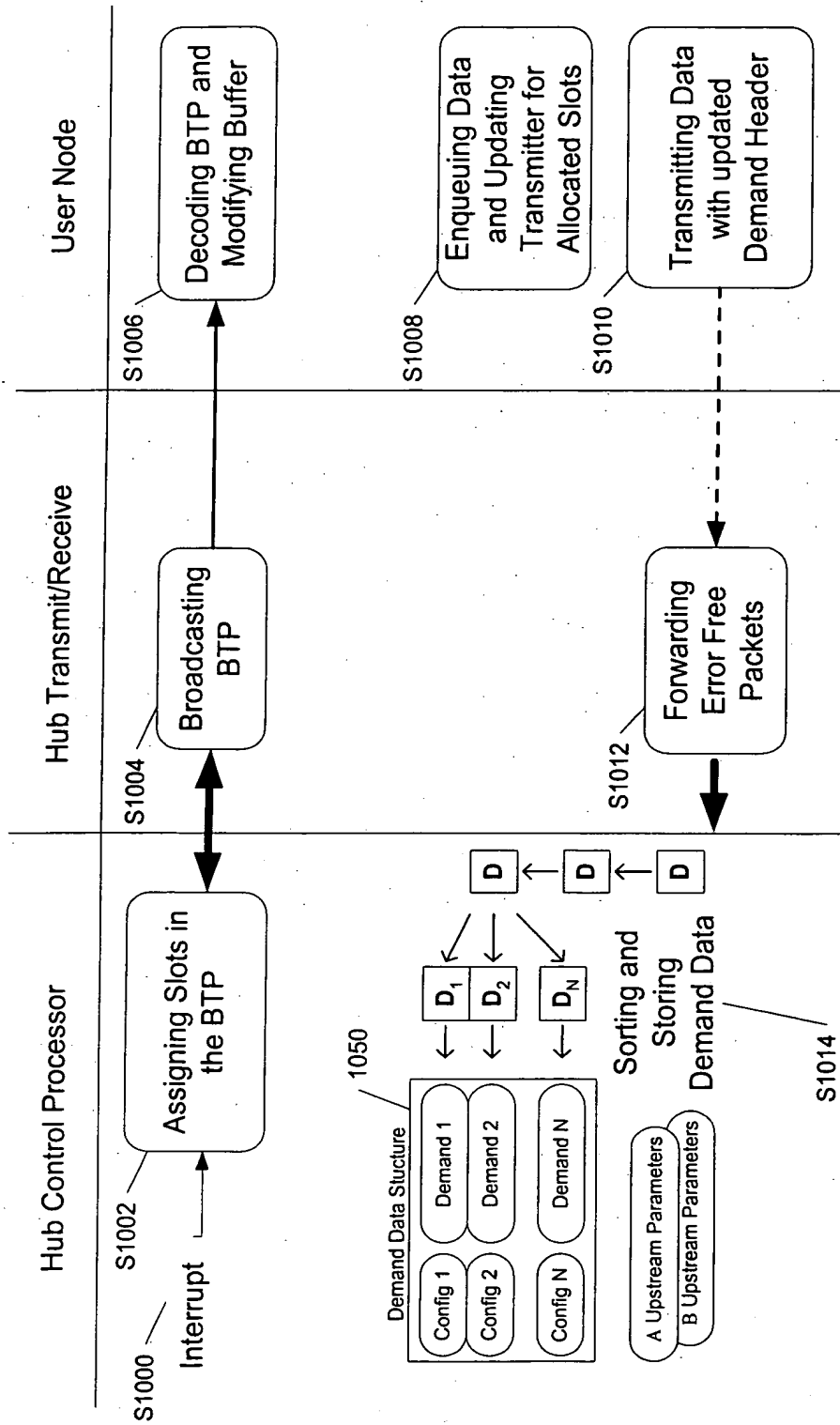

FIG. 10

S1008

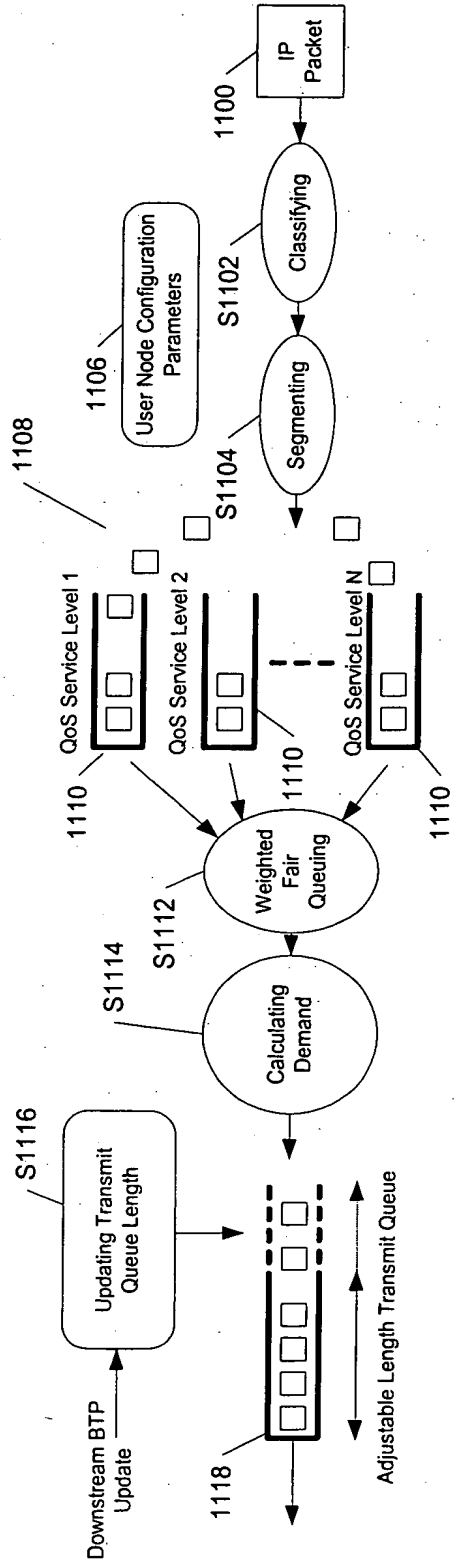

FIG. 11A

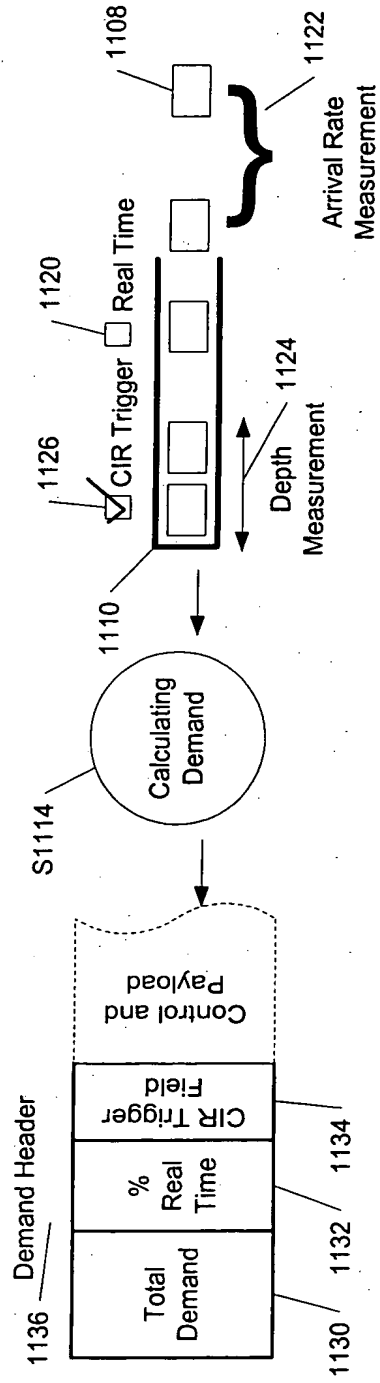

FIG. 11B

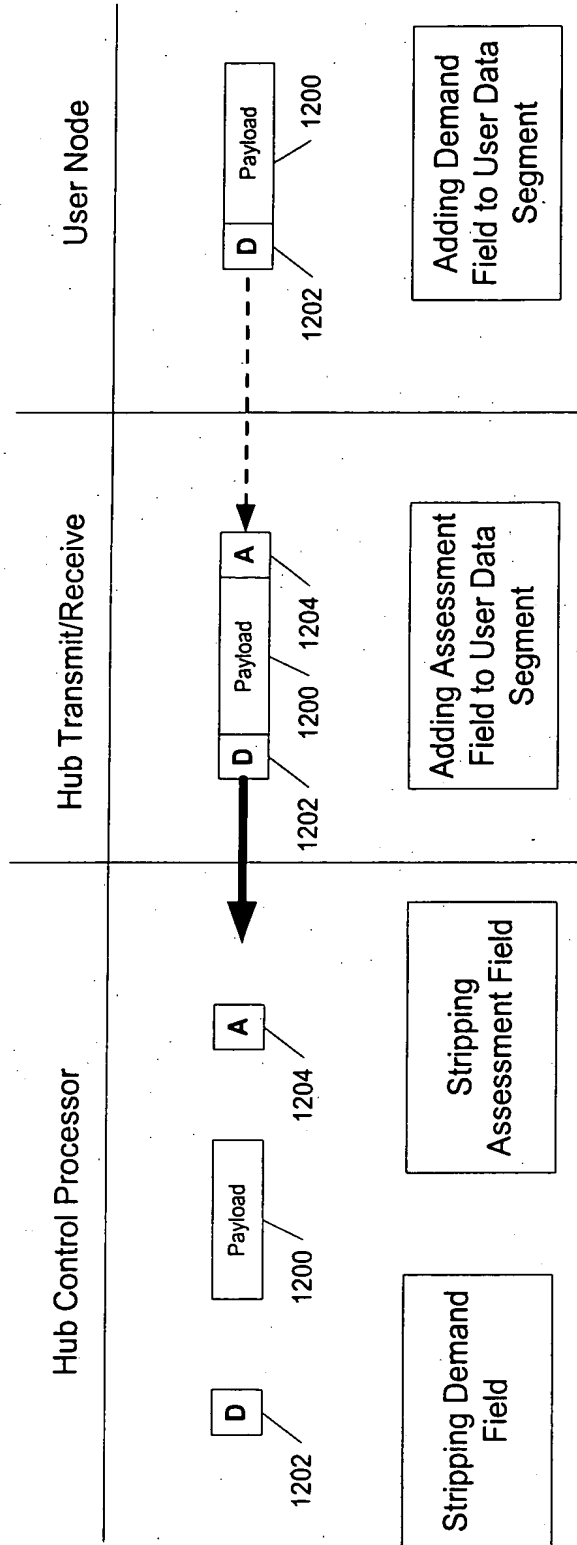

FIG. 12

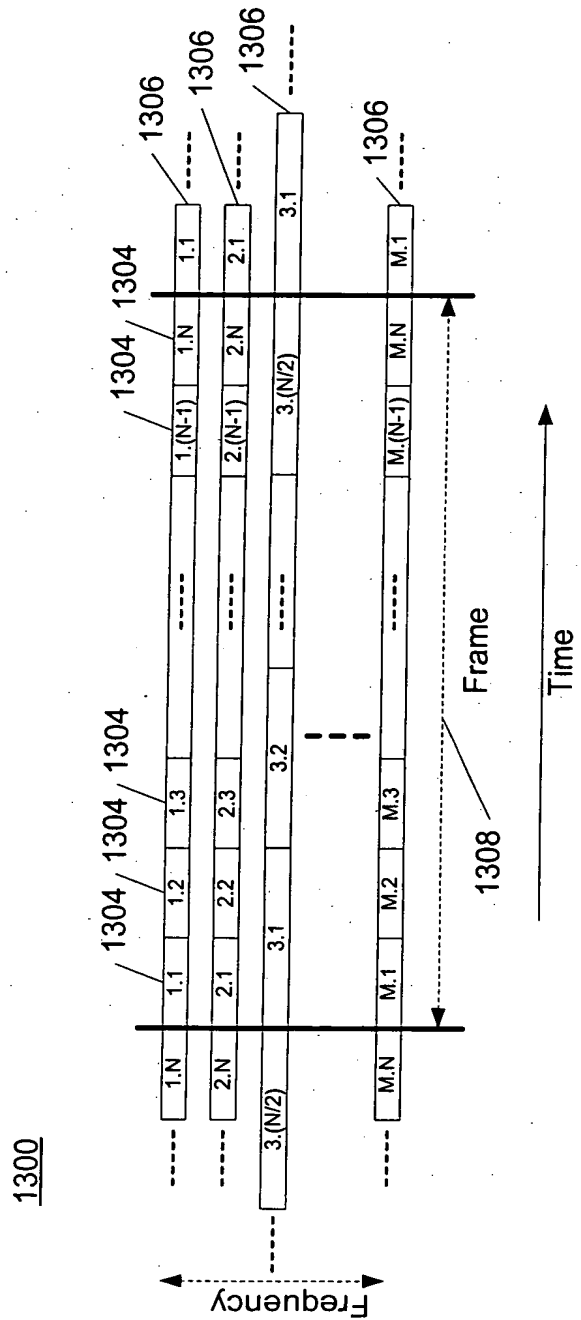
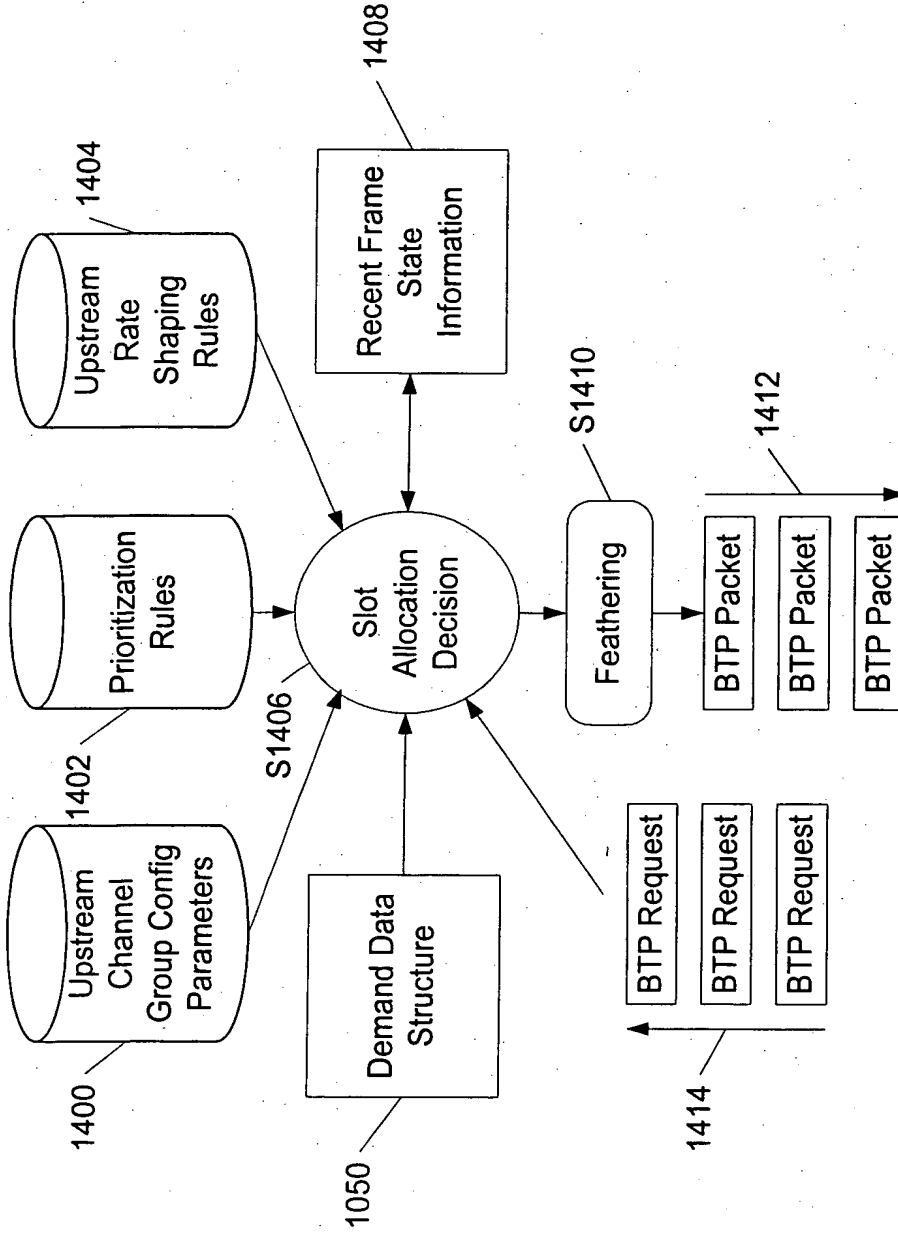

FIG. 13



S1002

FIG. 14

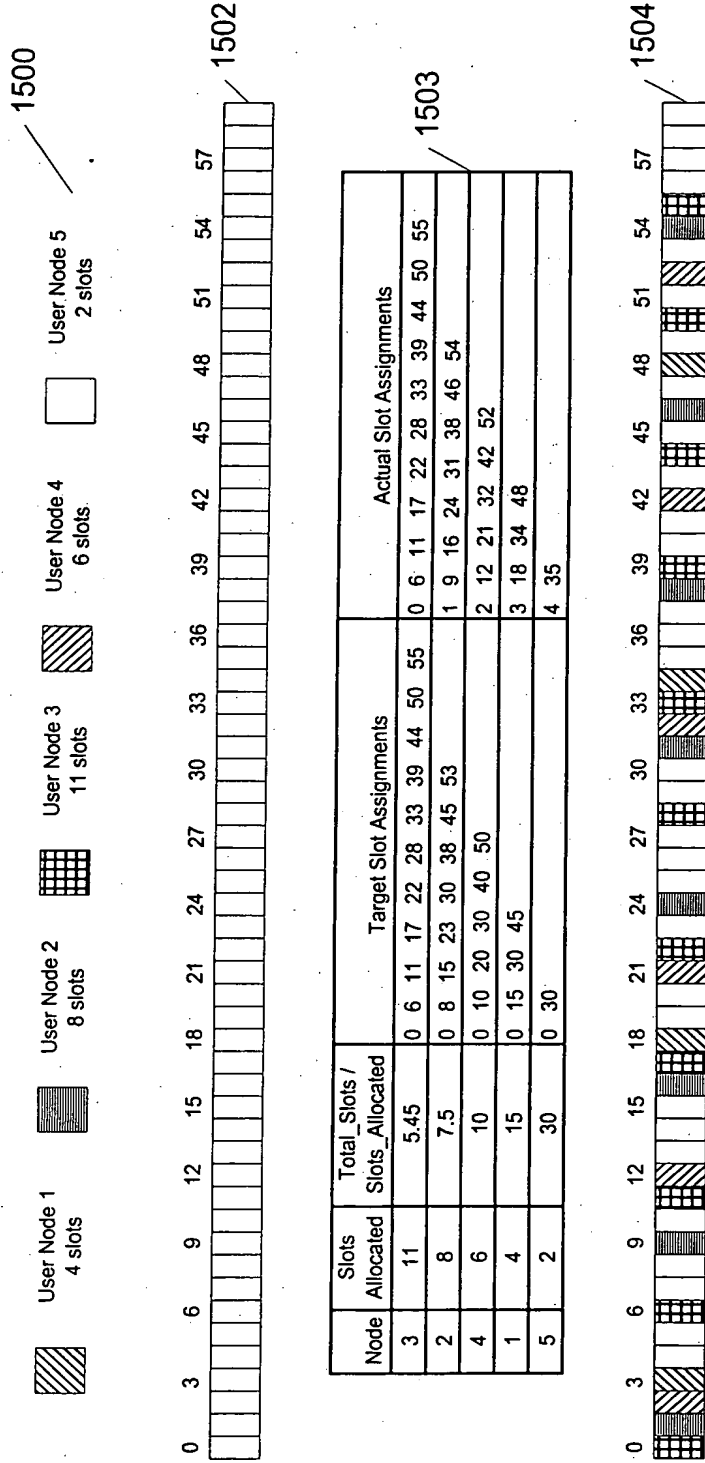

FIG. 15



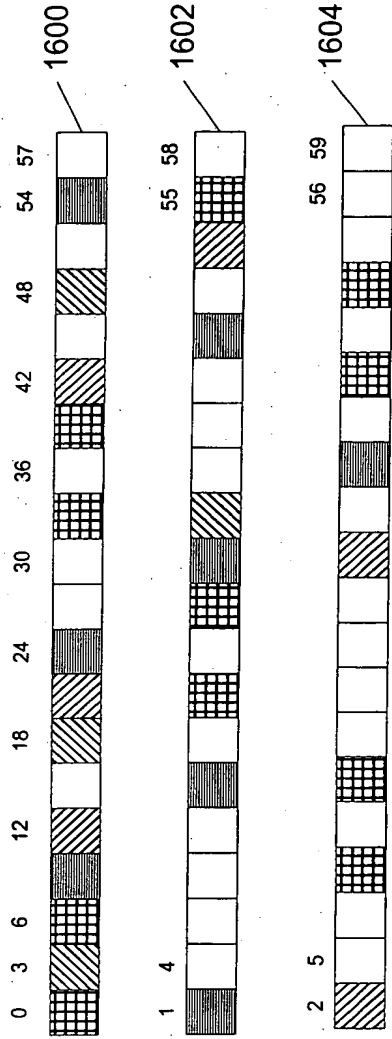

FIG. 16

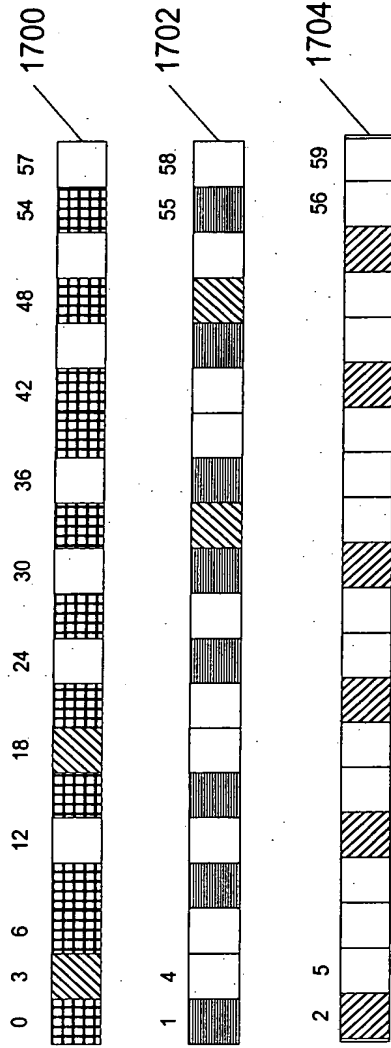

FIG. 17

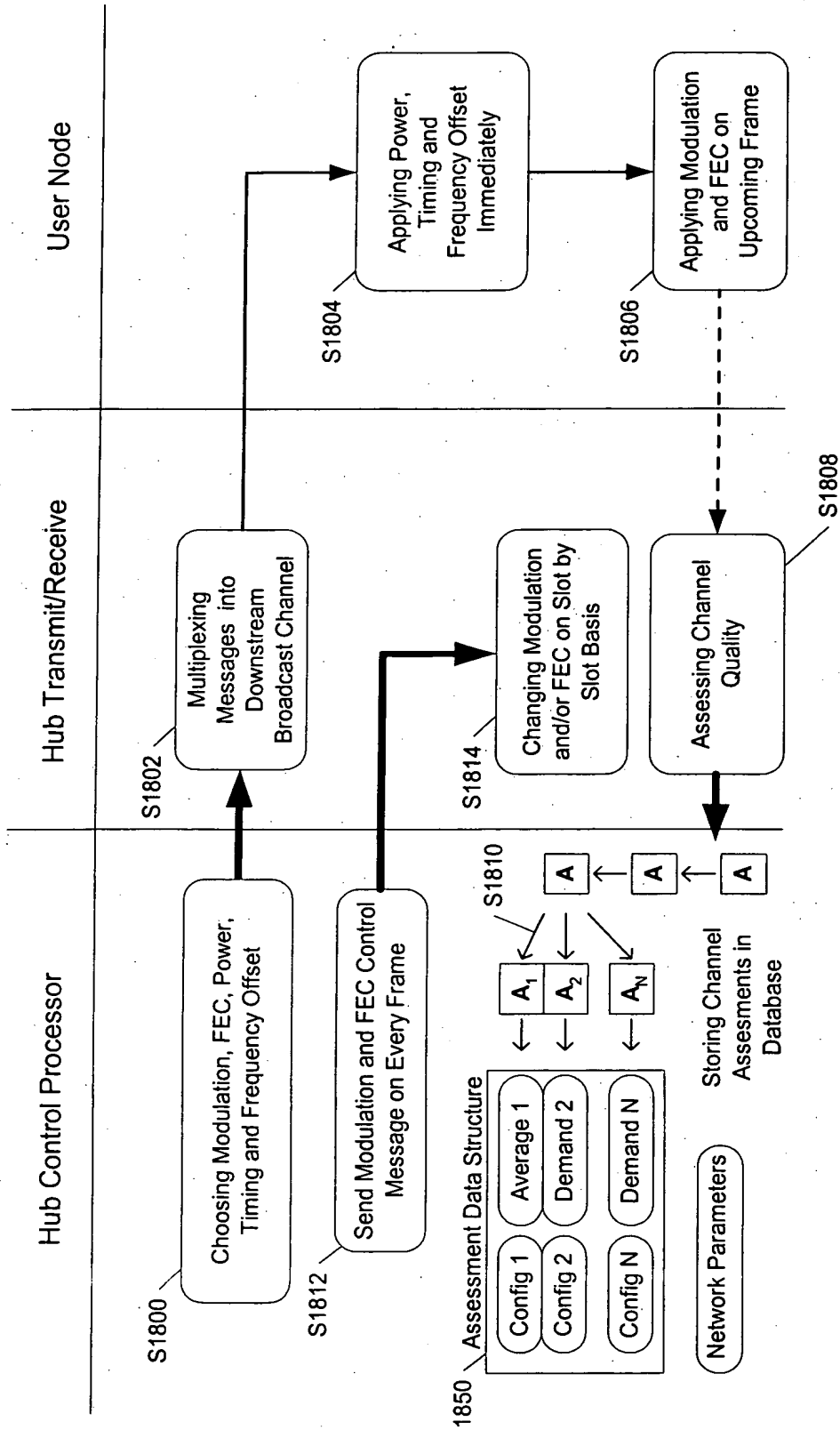

FIG. 18

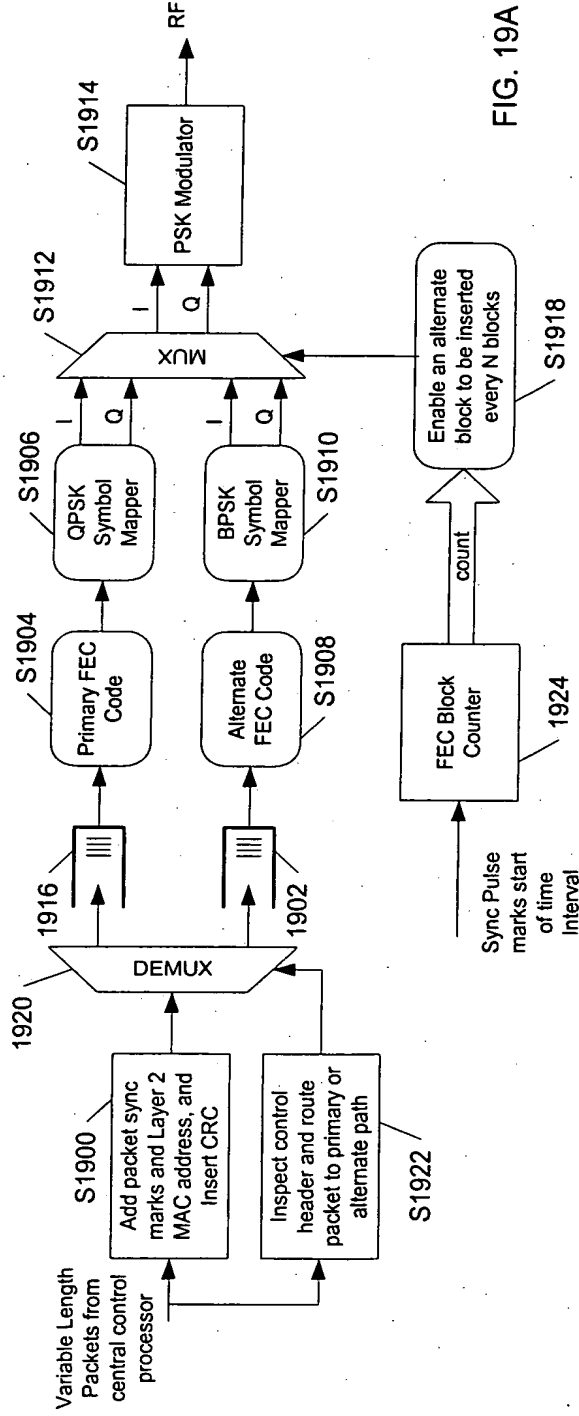

FIG. 19A

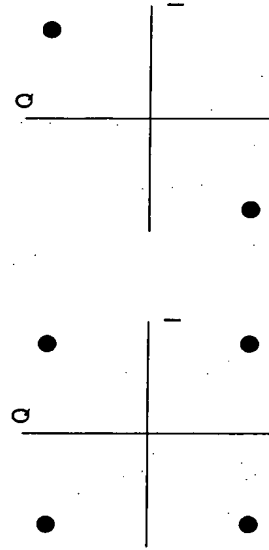

FIG. 19C

FIG. 19B

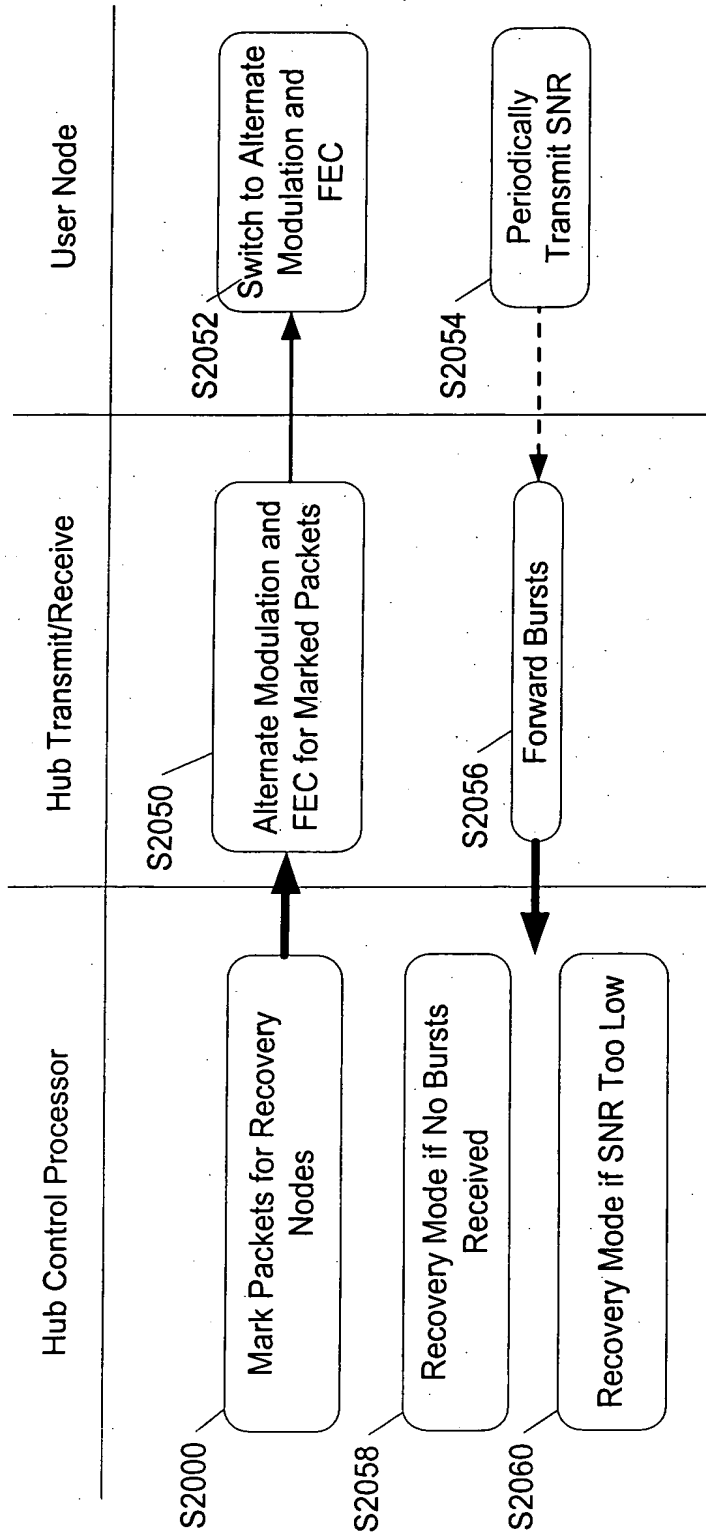

FIG. 20

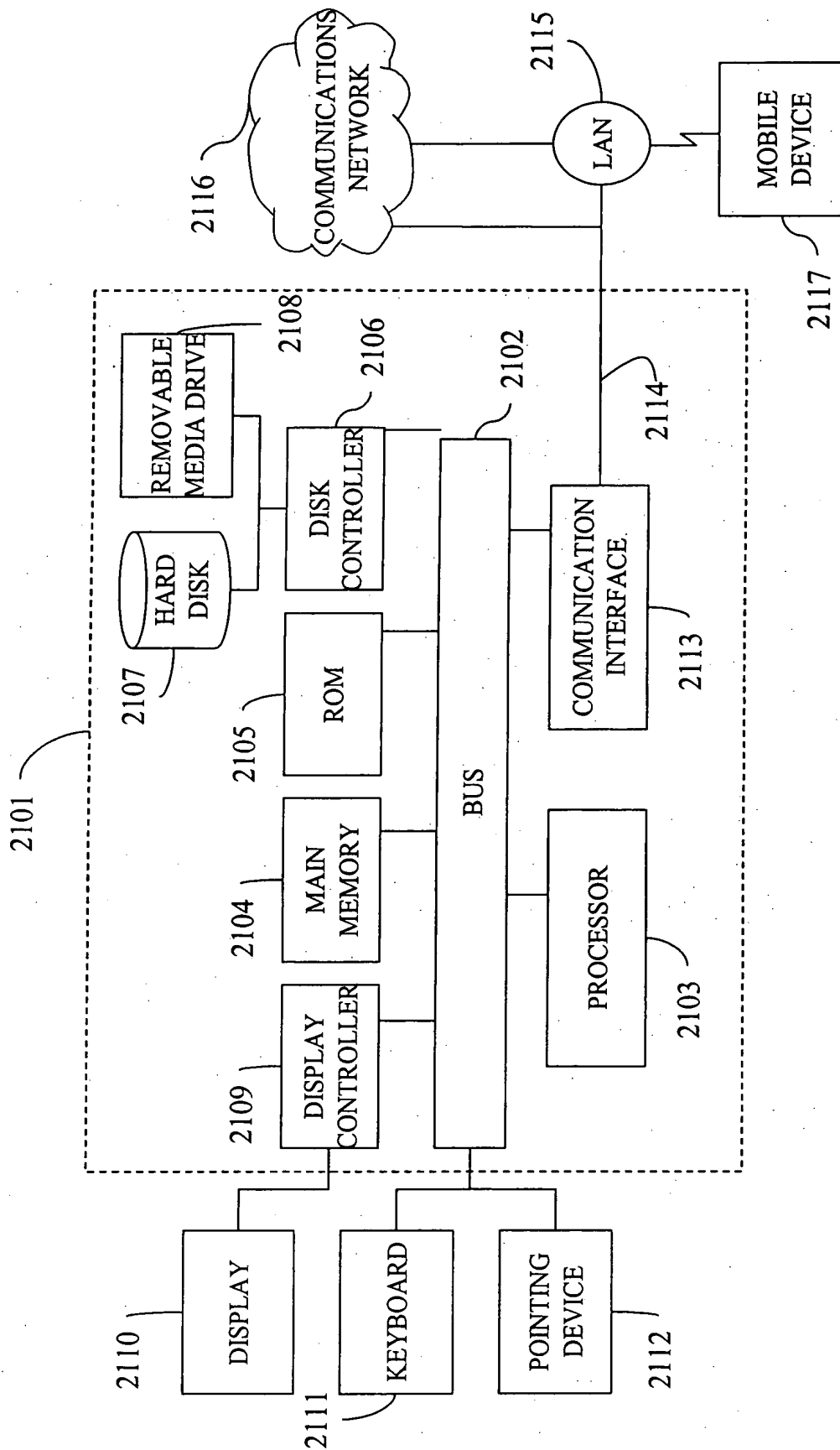

FIG. 21

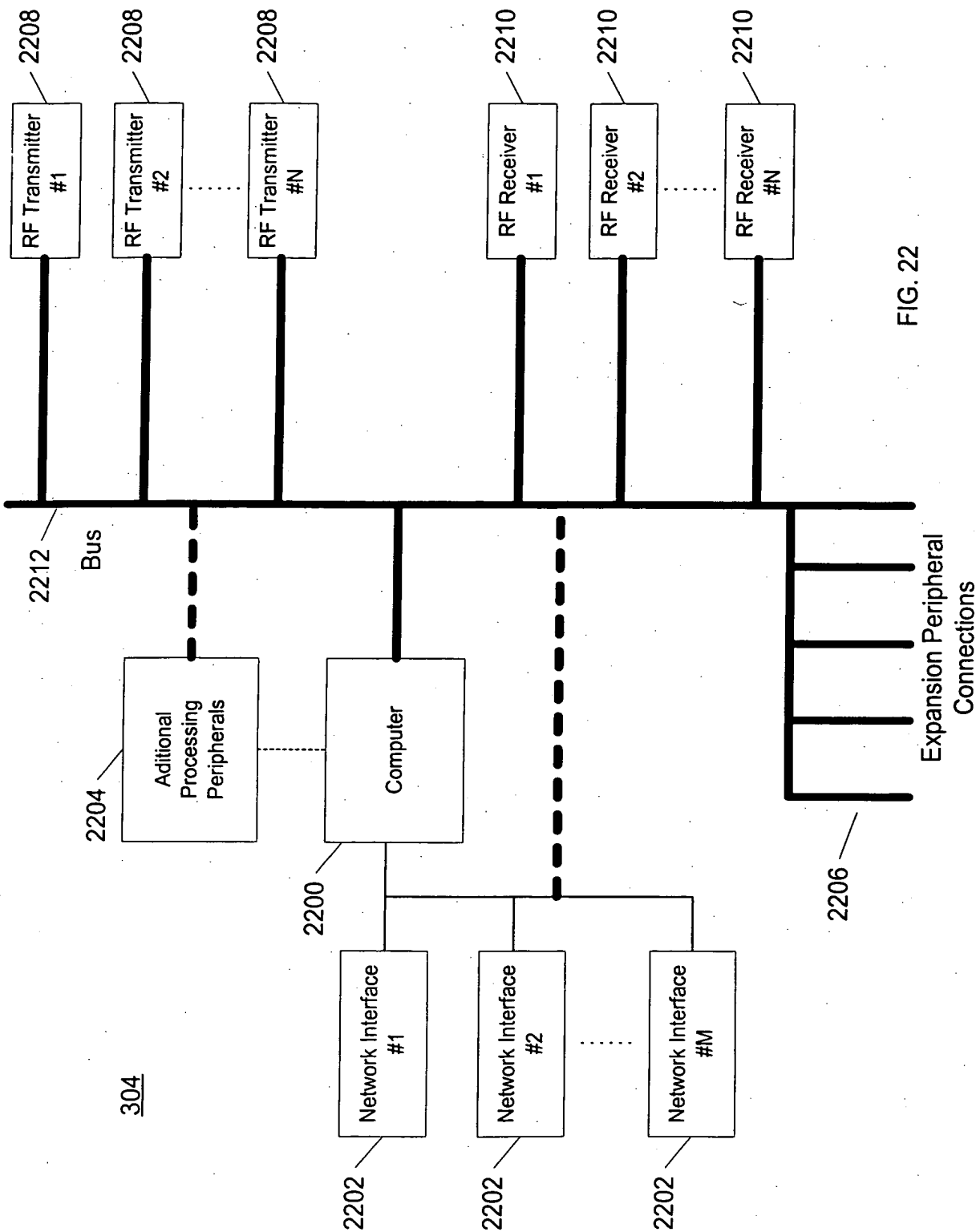

FIG. 22